



FFA Series Amplifiers OEM variants Operation Manual





Contents

Important safety information	pg 4
Amplifier overview	pg 5
Mechanical installation	pg 6
Mains power connection	pg 7-8
Audio signal input connection	pg 9
Audio power output & load connection	pg 10-11
Amplifier load protection	pg 12
Amplifier range technical specifications	pg 13
Amplifier application	pg 14
Amplifier servicing & warranty	pg 15



Important safety information

DO NOT REMOVE THE FFA-4004, FFA-6004, FFA-6000, FFA8000, FFA-10000 CHASSIS COVERS. THERE ARE NO USER SERVICEABLE PARTS INSIDE THE UNIT. REFER SERVICING TO QUALIFIED PERSON ONLY. THE FFA-4004, FFA-6004, FFA-6000, FFA-8000, FFA-10000 MUST BE EARTHED. IT SHOULD NOT BE NECESSARY TO REMOVE ANY PROTECTIVE EARTH OR SIGNAL CABLE SHEILD CONNECTIONS TO PREVENT GROUND LOOPS. ANY SUCH DISCONNECTIONS ARE OUTSIDE THE RECOMMENDED PRACTISE OF FFA AND WILL RENDER ANY EMC OR SAFETY CERTIFICATION VOID.

Amplifier overview

The FFA series of audio power amplifiers are high fidelity, high power output professional power amplifiers. FFA amplifiers are ideally suited for a variety of professional audio applications. We have thoroughly tested our products during the design phase and once we are satisfied that the design criteria has achieved we undertake extensive real world field trials to further prove the design. After the manufacturing process each amplifier is subjected to a series of test procedures including a high power 'burn in' or 'soak' period where the amplifier is driven into its specified minimum rated load.

FFA amplifier series features:

- FFA specialise in designing power efficient Class D amplifiers and high capacity switching power supplies.
- Innovative cooling systems for long term reliable performance –excellent thermal capacity for use in high temperature environments.
- Rugged chassis designs to ensure the electronic systems are protected.
- Exceptional audio sound quality, proven superb bass drive even when driving the toughest loads.
- 5 year no quibble manufacturers warranty.
- 'Soft start'/ full in-rush protection, amplifier clip limiter. DC shutdown, low mains voltage.
- Industry standard quality input/ output/mains connectors all manufactured by Neutrik.
- Designed and made entirely by FFA in Hertfordshire, England.

Mechanical installation



The amplifier is built around the industry standard 2 RU (88mm) high and 19" wide rack space. The amplifier requires a depth of 500mm from rack ear fixing points to rear of unit. Rear rack ear brackets are built in as standard, please use these to provide maximum protection for your investment. Any damage caused by insufficient support will not be covered by warranty. Allow 40mm clearance for amplifier front panel handles. Always use nylon type washers with standard M6 type rack fixing bolts to protect the anodised front panel.

Once installed in a rack care should be taken not to obstruct the air intake vents on the rear of the unit and air exhaust located centre of front panel. Obstructing airflow may cause the amplifier to trigger 'temperature protection' prematurely. The amplifier has one high CFM fan which is designed to pull cool air from the rear of the unit and blow hot air out of the front of the unit. The fan must only be used in this direction due to the high pressure cooling chamber in front of the fan. The fan is two 'speed' which is dependant on temperature within the unit.

IMPORTANT: The amplifier should not be sited directly near smoke or fog generating machines as glycol based smoke fluids are highly corrosive and will cause irreparable damage within the amplifier and will void its warranty.

The amplifier should not be exposed to rain or moisture either during storage or use. If the unit become wet isolate from electricity supply immediately and leave in a warm dry place to dry out. Should the amplifiers be transported from a cold location, for example a vehicle outside and taken into a warm venue condensation could occur inside the unit. Always allow time for the unit to acclimatise before powering the unit up.

Mains power connection

Warning! This appliance must be earthed at all times.

The FFA-4004 and FFA-6004 have a single Neutrik powercon power inlet which requires a maximum of 16A, 230V ac 50/60 Hz.

The FFA-6000, FFA-8000 and FFA-10000 amplifiers have two individual power supplies fitted with a Neutrik powercon mains inlet for each amplifier channel. Two 16A 230V ac circuits are required per FFA-6000, FFA-8000 and FFA-10000 amplifier. Total 32A 230V ac. The 2 amplifier channels are totally independent of each other and should a channel fail this will not affect the other channel.

The amplifier must be connected to an AC source with a three wire cable as supplied with the amplifier. The rack the amplifier is mounted in must also be connected to the same grounding circuit. The amplifier must not be used if the earth connection is not properly terminated – this is very important for personal safety and system ground control.

The wires in the mains lead are colour coded:

green and yellow = earth
blue = neutral
brown = live

Mains power supply requirement

FFA-4004	–	16A max
FFA-6004	–	16A max
FFA-6000	–	2 x 16A max
FFA-8000	–	2 x 16A max
FFA-10000	–	2 x 16A max

Power operational range

230V ac 50/60 Hz +- 10%



Mains power connection - continued

IMPORTANT: FFA-4004 and FFA-6004 have a single input mains fuse and the FFA-6000, FFA-8000 and FFA-10000 amplifiers have input mains fusing for each channel. If a mains fuse fails it must be replaced with the same type as supplied with the unit, this will ensure continued protection against fire and equipment damage.

If a fuse has failed without good reason, disconnect mains supply and using a medium flat blade screwdriver remove fuse carrier and replace fuse.

6.3mm x 32mm T20 A, 250V ac ceramic type fuse.

IMPORTANT If the amplifier develops a fault and internal fuses are blown it is the likelihood that there is a genuine fault with the amplifier. These fuses must not be replaced as further damage could occur. Please return the amplifier for service.

POWERING UP

The FFA-4004 and FFA-6004 have a single power on switch located on the right side of the front panel with green LED indicator for 'power on'. The FFA-6000, FFA-8000 and FFA-10000 have 2 power on switches one for each channel and green LED power on indicators.

All FFA amplifiers have 'soft start' or current in rush protection circuitry which slows down the time the amplifiers bulk storage capacitors are charged and prevents accidental tripping of mains safety breakers.

After 'switch on', each amplifier channel's clip and protect LED will glow red for approximately 4 seconds until the amplifier is ready for operation. The clip light will also glow red if an input signal is present until the amplifier is ready for operation.

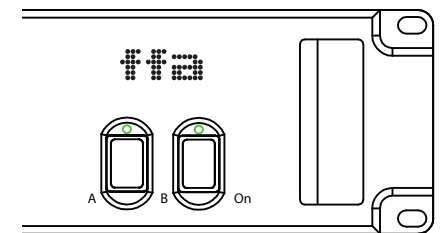
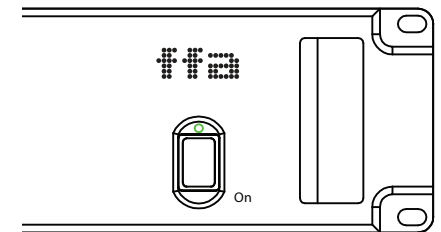

Audio signal input connections

Each amplifier channel has an input (female XLR) and parallel link (male XLR). The inputs are 20k Ohm electronically balanced. The 'link' XLR can be used either to link channel A and B together to provide a 'mono' signal (for example mono bass signals) or to carry a signal to a further adjacent amplifier.



Four channel models have input and parallel link on each channel.

We recommend for best audio and noise performance use balanced audio signal cable only, wired as follows:

XLR pin 1 = ground

XLR pin 2 = signal 'HOT' or in phase + positive.

XLR pin 3 = signal 'COLD' or out of phase - negative.

Unbalanced connections can be used if pins 1 and 3 are connected together via a wire link. Pin 2 is signal HOT + in phase.

IMPORTANT ! At all times 'pin 1' must be connected to the shield of the audio signal cable as this will ensure continued compliance with EMC legislation.

AUDIO SIGNAL LEVEL CONTROL

Each channel has a 41 step potentiometer located on the front panel of the amplifier.

Amplifier gain = 32 dB.

2 channel

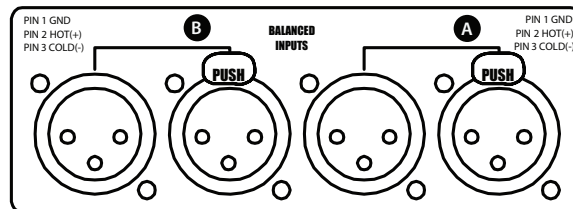

4 channel

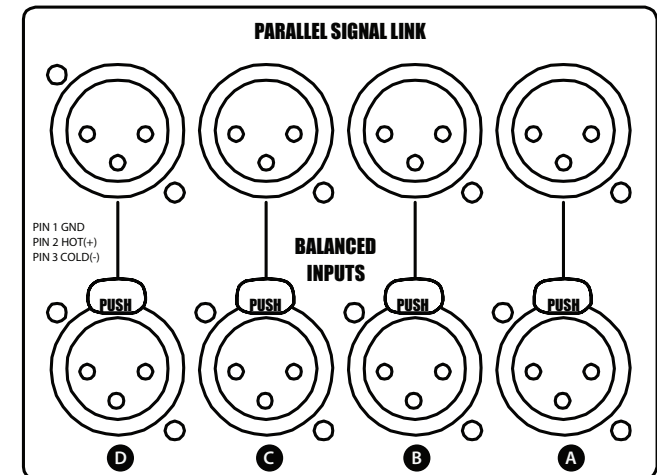

Audio output and load connection

WARNING! ALL FFA AUDIO POWER AMPLIFIERS CAN CREATE VERY HIGH SOUND PRESSURE LEVELS.

EXPOSURE WITHOUT ADEQUATE HEARING PROTECTION COULD CAUSE PERMANENT HEARING LOSS.

NEUTRIK NL4 OR NL2 TYPE CABLE CONNECTORS ARE TO BE USED FOR CONNECTING THE AMPLIFIER TO LOUDSPEAKERS.

FFA-4004, FFA-6004.

FFA-4004 and FFA-6004 amplifiers are designed to drive a minimum of 4 Ohms load per channel.

A typical load for each amplifier channel would be 2 x 8 Ohm loudspeakers connected in parallel.

Each channel has its own Neutrik SpeakON audio output socket.

FFA-4004 and FFA-6004 has its output sockets internally connected as follows.

Channel A = 1+ 1-, 2+ 2- = Channel B

Channel B = 1+ 1 -

Channel C = 1+ 1- 2+ 2- = Channel D

Channel D = 1+ 1 -

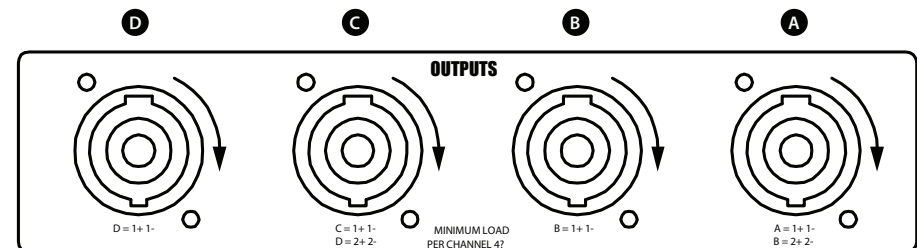

Channel A and Channel C allow the use of a 4 core loudspeaker cable to be connected directly into the output. This is useful when connecting the amplifier outputs to a biamplified loudspeaker system without using an ancillary patching panel.

An example of this would be a monitor or stage wedge loudspeaker where Channel A would connect to the bass section and Channel B would connect to the high frequency unit within the loudspeaker enclosure. An electronic cross over filter used in conjunction with the four channel amplifier would process the audio signals. An analogue cross over filter card is available as an accessory which is internally fitted within the amplifier and conditions the signals to each channel as required. This card is factory programmable and is fitted to the four channel amplifier at time of ordering from the FFA factory and should be requested when ordering.

Audio output and load connection

FFA-6000, FFA-8000, FFA-10000.

FFA-6000, FFA-8000 and FFA-10000 amplifiers are specifically designed to drive down to a minimum of 2 Ohms. A load example for each channel could be 4 x 8 Ohm bass drivers connected in parallel.

Each channel has a parallel pair of Neutrik SpeakON sockets.

All poles on the chassis connector are connected internally to the amplifier outputs and are connect as follows.

- 1+ = positive
- 1- = negative
- 2+ = positive
- 2- = negative

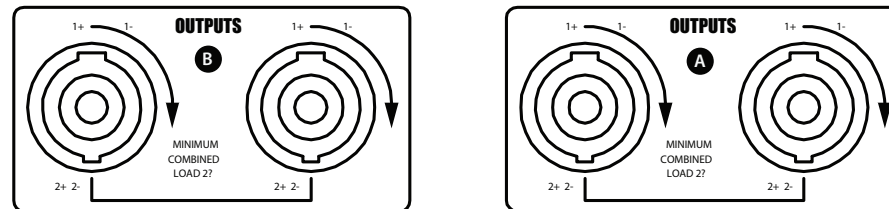

We have specified a pair of parallel outputs so that it is possible to use 2 x 4 core loudspeaker cables on each channel output and connect these to a pair of 2x18" type bass cabinets.

If the bass loudspeakers input SpeakOn connectors is wired the same as the amplifier output each driver would then have its own circuit connection. This connection of amplifier and loudspeaker driver ensures that the lowest impedance path possible and gives the best audio performance. We would recommend the use of 4mm² conductor loudspeaker cable.

Load protection

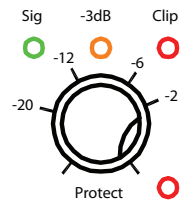

CLIP LIMITER

A clip limiter will engage if excessive clipped signal occurs. A degree of clip is allowed before the limiter is engaged. The limiter will disengage when the clipped signal returns to an un-clipped state. The clip limiter is indicated by the 'clip' red LED flashing in line with the audio signal.

DC PROTECT

If DC occurs due to an amplifier fault or inappropriate audio input signal the amplifier DC protection circuit will engage and the amplifier will turn off. The circuit will reset when the amplifier is turned back on. The amplifier will continue to turn off if a genuine DC fault condition is present. The amplifier should be returned for service if this occurs.

AMPLIFIER PROTECTION

The amplifier will mute in event of a load short circuit or current overload.

THERMAL CONSIDERATIONS WHEN USING YOUR FFA AMPLIFIER

IMPORTANT! REAR AIR INLETS AND FRONT HOT AIR EXHAUSTS MUST NOT BE OBSTRUCTED. THIS COULD CAUSE THE AMPLIFIER TO MUTE ITS AUDIO OUTPUTS PREMATURELY.

Individual amplifier channels will mute if the thermal threshold is exceeded. Amplifier channels will un-mute when sufficient cooling has taken place. If the FFA amplifiers are to be fitted within a sealed type rack enclosure with input fans fitted to the rack lids, these fans must be capable of at least 120 CFM per amplifier fitted within the rack.

Care should be taken when mixing amplifier brands within the same rack enclosure with respect to cooling airflow orientation. Ideally airflow should all go in the same direction. – Air intake: FFA amplifiers intake cool air from the rear of the amplifier and the hot air exhaust is through the front panel of the amplifier.

FFA air flow convention is used as we believe this is the best way to remove hot air away from the amplifier and the rack it is installed within. The rear of the amplifier rack can be crowded with cables and possibly patch panels which can impede the hot air as it is expelled from the amplifier.

2 channel

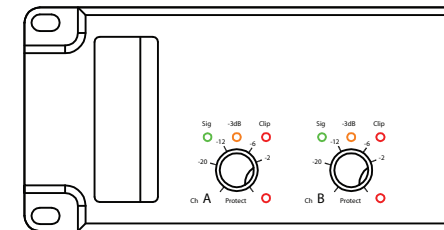

4 channel

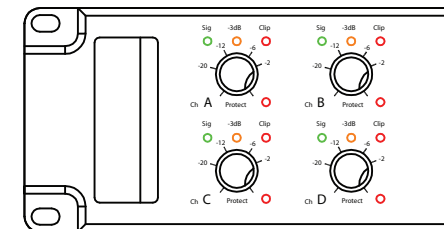

Ampilifier Specifications

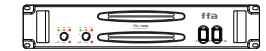
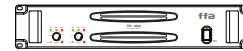
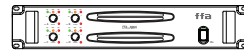
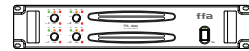

Product Model	FFA-4004	FFA-6004	FFA-6000	FFA-8000	FFA-10000
Power ratings	Measured per channel, driven at 1 kHz sine wave, 240 VAC mains supply voltage to no more than 1% THD				
Load:					
8 ohms	650 W	900 W	1000 W	1250 W	1500 W
4 ohms	1000 W	1500 W	1800 W	2400 W	3000 W
2 ohms	N/A	N/A	3000 W	4000 W	5000 W
Maximum output voltage at rated load - V peak	105 V	135 V	130 V	150 V	175 V
Gain	32dB				
THD+N	Typical 0.05% 4 Ohm 1 kHz THD+N				
Input impedance	20 k Ohms electronically balanced				
Frequency response	20 Hz - 20 kHz				
Cooling system	single high CFM fan rear to front airflow				
Load protection	DC on output and clip limiter				
Amplifier protection	Short circuit on output connector, over current, thermal				
Indicators	green LED = signal present yellow LED = -3dB drive clip red LED = clip protect red LED = over current, thermal, occasional flash equals clip limiter activated, 4 second mute on amplifier power up.				
Power connector	NACFCA 20A 230 VAC Neutrik PowerCon connector.				
Power operational range	230VAC +-10% 50/60 Hz.				
Dimensions	H88mm x W483mm x D510mm. Standard 2 RU rack mount				
Weight	10 kg	10 kg	12 kg	12 kg	12 kg

FFA-4004

Overview:

Used to drive small - medium full range and dedicated bass loudspeakers, for touring or installation, ideal for components within touring loudspeakers such as mid range and HF, 4 Ohm drive.



Suitable Applications:

Small full range loudspeaker for example 5"-10" + 1" driver compliment, smaller bass units 8" -10" drivers High power mid range and HF drivers in multi way installed sound or touring sound systems Smaller stage monitors bi amp or full range

FFA-6000

Overview:

General purpose bass amplifier used anywhere high quality bass reinforcement in required.



Suitable Applications:

Small low mid or smaller bass cabinets 2x12", 2x 15", 2x18" – 2 Ohm drive

FFA-6004

Overview:

Medium to larger full range and dedicated bass loudspeakers, bi amplified stage monitor systems, components within large format touring or installation loudspeakers low mid, high mid and HF, 4 ohm drive.



Suitable Applications:

Medium to large full range loudspeakers 10"-15" drivers + 1" 1.5" HF Low mid, high and HF in larger multi way systems installed or touring. High power stage monitors 2x12" or 15" +1.5" Medium bass 2x12" 15" or 1x18"

FFA- 8000 / 10000

Bass application amplifiers:

Very high power output amplifiers ideal for the most demanding bass and sub bass reinforcement.



FFA-6000 Small low mid or smaller bass 2x12", 2x 15", 2x18" – 2 Ohm drive
FFA-8000 Medium low mid 2x12", 2x 15", 2x18" – 2 Ohm drive
FFA-10000 Large 2x18" 21" 24" very high power bass systems – 2 ohm drive

Amplifier Servicing

WARNING! FFA ACCEPTS NO RESPONSIBILITY FOR DAMAGE OR INJURY CAUSED BY OPENING THE FFA-4004, FFA-6004, FFA-6000, FFA-8000 AND FFA-10000.

ALWAYS REFER SERVICING TO QUALIFIED PERSON !

THE AMPLIFIER HAS VERY HIGH VOLTAGES WHICH ARE STORED WITHIN THE UNIT AFTER THE REMOVAL OF MAINS INPUT. REMOVAL OF AMPLIFIER LID IS NOT ADVISABLE TO NON-QUALIFIED PERSONEL!

1. If a fault occurs with the amplifier please call your dealer or FFA for advice.
2. There are no user service parts inside the unit.
3. Any internal fuses will only blow if a 'real' problem occurs, the amplifier must be returned to FFA for service/repair.
4. If in doubt please call, we are here to assist with any FFA amplifier issues.

Warranty Information

FFA-4004, FFA-6004, FFA-6000, FFA-8000 and FFA-10000 models when sold to an end user by FFA or FFA authorised distributor/dealer are warranted by the seller against defects in workmanship and materials for a period of 5 (five) years from delivery date.

Faults arising from misuse, unauthorised modifications or accidents are not covered under this warranty, as is damage to any other equipment caused by inappropriate operation of the FFA-4004, FFA-6004, FFA-6000, FFA-8000 and FFA-10000. Specifically, but not exclusively, damage caused by smoke fluid or related substances that may contaminate the unit are not covered by this warranty. No other warranty is expressed or implied.

If a fault is found on your FFA amplifier. It should be returned to the dealer where bought in its original shipping carton pre-paid. The unit will be returned when repaired. Please include a description of fault, amplifier serial number and importantly your address and contact details.





Please record purchase details below for future reference:

Dealer name:

Dealer tel no:

Dealer contact name:

Invoice/receipt no:

Date of purchase:

Dealer address:

Postcode:

FFA serial numbers:

Trades Description Act: FFA have a policy of continued product development and accordingly reserve the right to change features and specifications without prior notice.





Power on demand

www.fullfataudio.com





www.fullfataudio.com

Full Fat Audio Ltd Unit 4, The Granary, Fairclough Hall Farm, Weston, Hitchin, Hertfordshire, SG4 7DP UK Tel: +44 (0)1462 790700 email: info@fullfataudio.com